

Celsi

Modello/Model	Watt	Alimentazione/Input
DW141	9,5W	230Vac
DW142	14W	230Vac
DW143	20W	230Vac
DW144	37W	230Vac
DW145	50W	230Vac

ISTRUZIONI PER L'INSTALLAZIONE/INSTALLATION INSTRUCTIONS

IT ISTRUZIONI DI SICUREZZA

- L'apparecchio deve essere installato, connesso e testato da un elettricista qualificato e in accordo con le norme vigenti.
- Disconnettere l'alimentatore prima dell'installazione o della manutenzione dell'apparecchio e assicurarsi che i cavi non vengano danneggiati.
- Pulire l'apparecchio con un panno leggero e un detergente a pH neutro.
- Laddove si abusasse dell'apparecchio o si apportassero modifiche, la garanzia sarebbe da considerarsi nulla.
- Il fornitore è libero di apportare modifiche al design, specificazioni ed istruzioni di montaggio.
- Assicurarsi che l'alimentatore non abbia cariche elettriche residue. È consigliato cortocircuitare l'uscita del l'alimentatore prima di collegare il Led.

EN SAFETY INSTRUCTIONS

- The device should be installed, connected and tested by a qualified electrician, and in accordance with local regulations.
- Turn off the power supply before installation or maintenance of the device, and make sure that the cables will not be squeezed or damaged by sharp edges.
- Clean the device with a soft cloth and a standard pH neutral detergent. Stainless steel surfaces should be maintained regularly.
- Misuse or changes to the device cause loss of warranty.
- The manufacturer is free to change the design, specifications and instructions for assembly.
- Ensure that power supply doesn't keep residual electric charges. It is recommended to short-circuit output before connecting LEDs.

1 CUTTING SIZE:

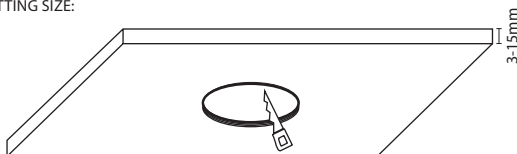

- DW141 - Ø70mm
- DW142 - Ø105mm
- DW143 - Ø135mm
- DW144 - Ø165mm
- DW145 - Ø205mm

IT Realizzare il foro nel soffitto.

EN Make, in the ceiling, the hole for the light fitting.

2

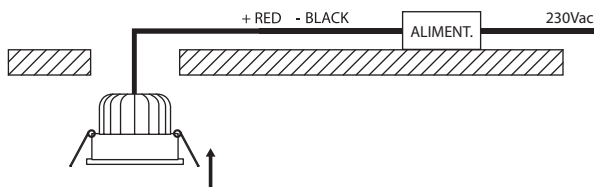

IT Gli apparecchi, per sicurezza nei confronti del grado di protezione, sono sigillati e forniti di cavo di alimentazione. Realizzare la connessione elettrica semplicemente collegando i fili all'alimentatore, poi fissate l'apparecchio nel soffitto.

EN Devices, to ensure their IP protection degree, have been sealed and equipped with alimentation cable. Realize electrical connection just connecting the wires to the power supply, then place and fix the device in the ceiling.

3

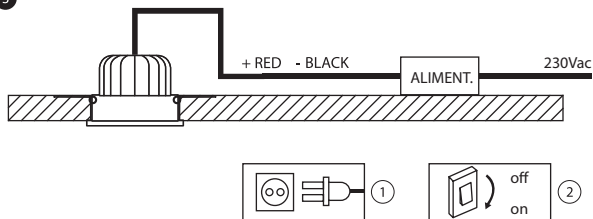

IT Verificare la corretta esecuzione dei collegamenti al circuito di alimentazione, procedere con l'accensione.

EN After verifying the correct circuit, wiring to the power supply, switch on the electricity for the light fitting.

DW141

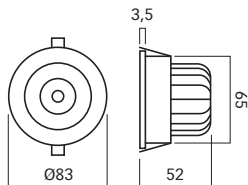

DW142

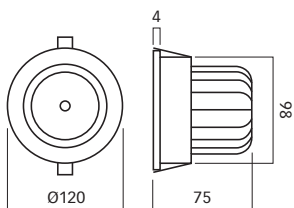

DW143

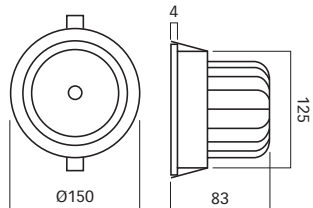

DW144

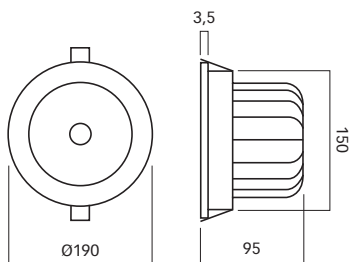

DW145

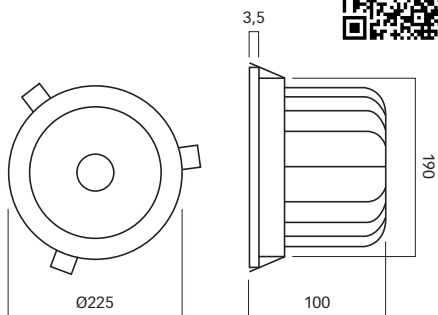

ACCESSORI/ACCESSORIES

SERIE APC
CORRENTE COSTANTE
CONSTANT CURRENT



APC012.350



APC020.500



APC020.650



DCJOLLY

Dimmer 1-10V/Push



AL030DALI

Dimmer DALI

DW141	1	-	-
DW142	-	1	-
DW143	-	-	1

SERIE APC
CORRENTE COSTANTE
CONSTANT CURRENT



APC030.700



APC050.1400



AL056P

Dimmer 1-10V/Push



AL060DALI

Dimmer DALI

DW144	1	-	-
DW145	-	1	-

Alimentatori inclusi/Drivers included

Centralina non inclusa/Controller not included